

“The Dealers Choice”
for Bindery Equipment Parts

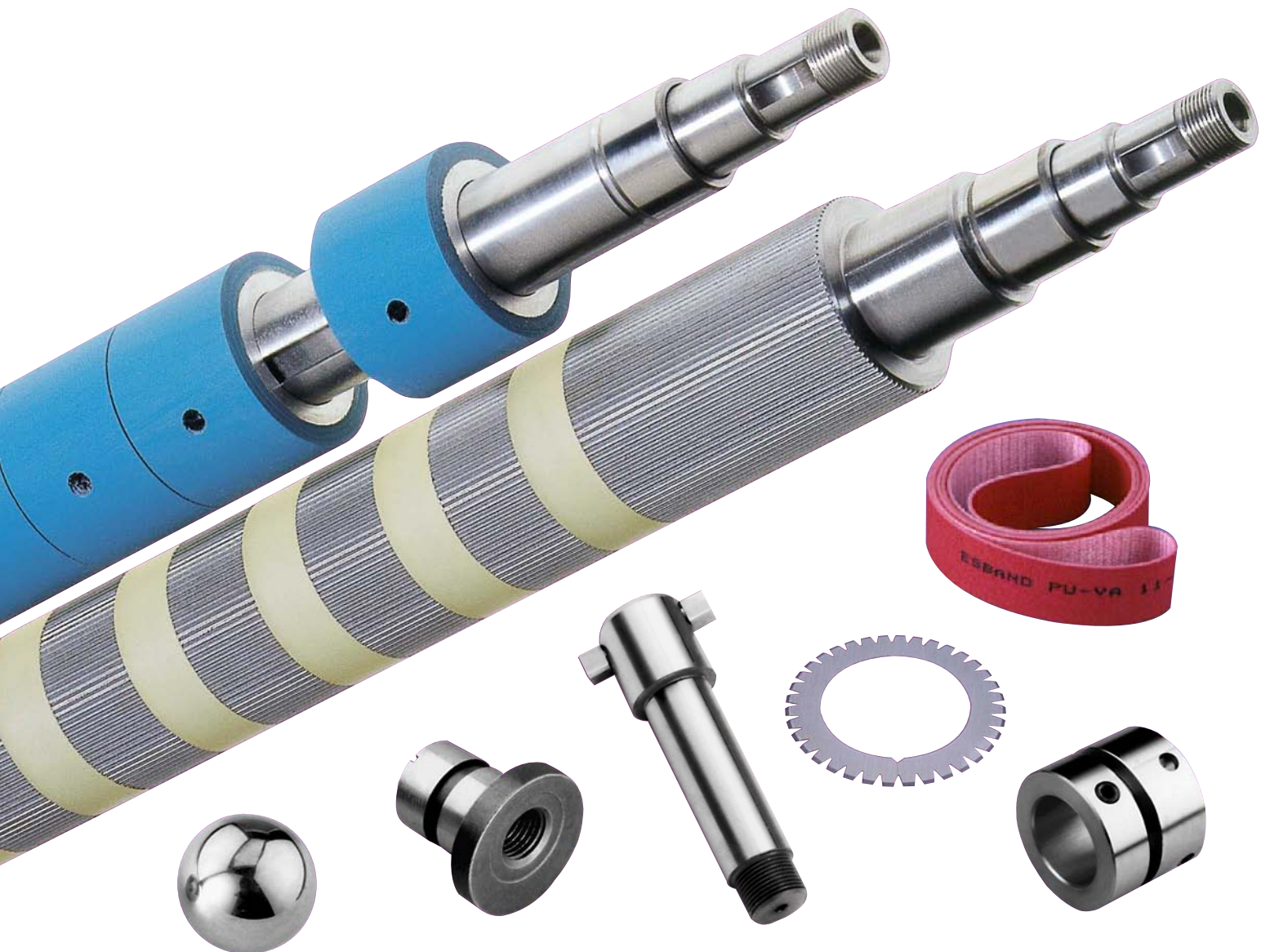

Where Low Prices and High Quality equal Profits!

Manufacturing Directions Inc. 11639 Township Rd. #76, Quincy, OH 43343 (937) 585-5290



What makes MDI “The Roller Specialists” ?

CNC Machining for a Precision Product at an Unbeatable Price!

At MDI, our commitment to quality is reflected in every part we make. Our manufacturing plant in Quincy, Ohio has the latest machining technology, allowing us to produce parts of unsurpassed quality at reasonable prices.

Our central location allows for speedy shipments to all parts of the country. We maintain a large assortment of parts in stock - call us with your needs. From basic maintenance and wear parts to complete rebuilds, choose the company that has been the leading manufacturer of roller & folder parts for over 20 years. The next time you need folder parts, call MDI – “The Roller Specialists” !

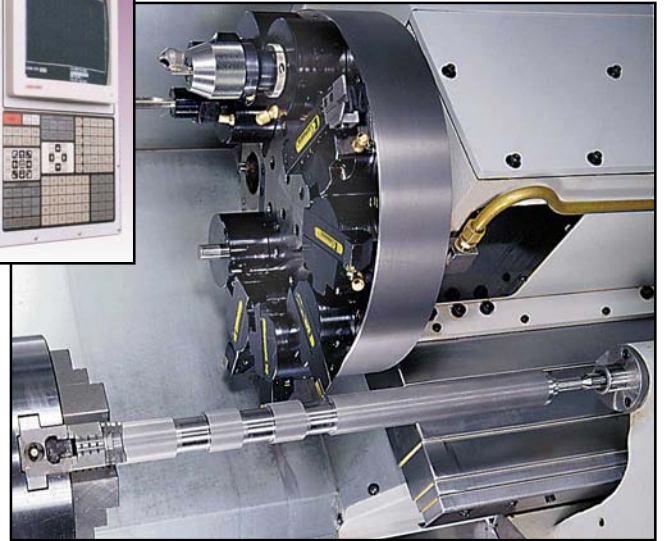

• Full Year’s Guarantee on Materials and Workmanship. Made in USA!

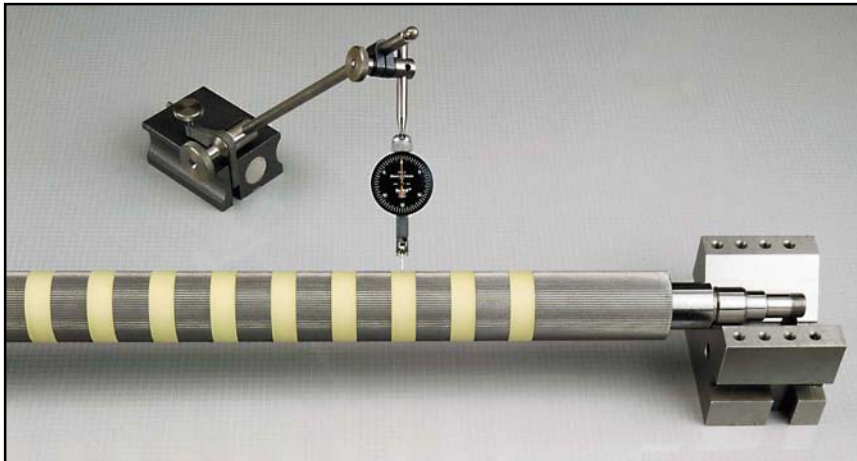

Fits:

- ★ STAHL
- ★ MBO
- ★ BAUM
- ★ O&M
- ★ PROFOLD
- ★ CHALLENGE
- ★ CLEVELAND
- and more!

★ The Above Names Are Registered Trademarks

QUALITY CONTROL

At MDI we provide parts of the absolute highest quality, because we control the manufacturing process. From the time the stock is cut, to the final finish grind, our products undergo rigorous testing to assure that they meet or exceed industry specifications for their application.

*Unauthorized use of photos or copy is prohibited.
© Manufacturing Directions, Inc. 2009*

Call MDI for High Quality *Non-OEM Replacement Parts

FOLD ROLLERS

NEW! *Spiral Rollers*



1/8" wide steel knurl x 3/8" molded-in polyurethane.

ROLLERS TO FIT MBO*

Model	Price
B115, B18, B118, B20, B120, B21	\$325.00
T49	345.00
B123, B26, B26S, T65	360.00
B30, B32S	395.00
Roller Regrinding (any size)	65.00

*MBO is a registered trademark

- **New Spiral Patterns Available For Any Folder**
- **Regrinding Of Your Present Spiral Rollers Also Available**
(Performed to true up and extend the life of your existing rollers)

Popular in late model folding machines, the spiral roller helps to flatten the sheet, avoiding wrinkles as the paper goes through the folding process. This occurs because the spirals move in opposite directions on opposing rollers.

Overlapping Soft Polyurethane Rollers - best for aqueous coated stocks

- The overlapping design insures maximum gripping ability.

ADDED BONUS
During operation, centrifugal force further expands the polyurethane creating extra grip.

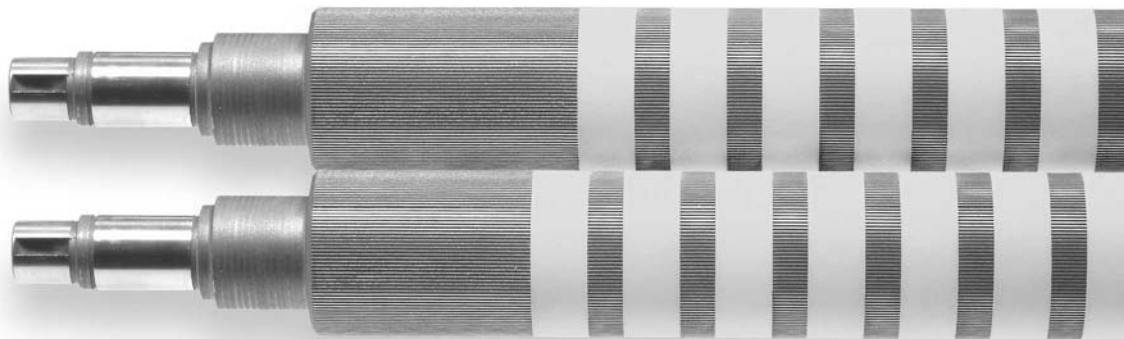

• 15mm Soft Poly Foam x 9mm Knurled Steel = 3mm overlap

MDI Segmented Rollers - a must when you glue and fold!

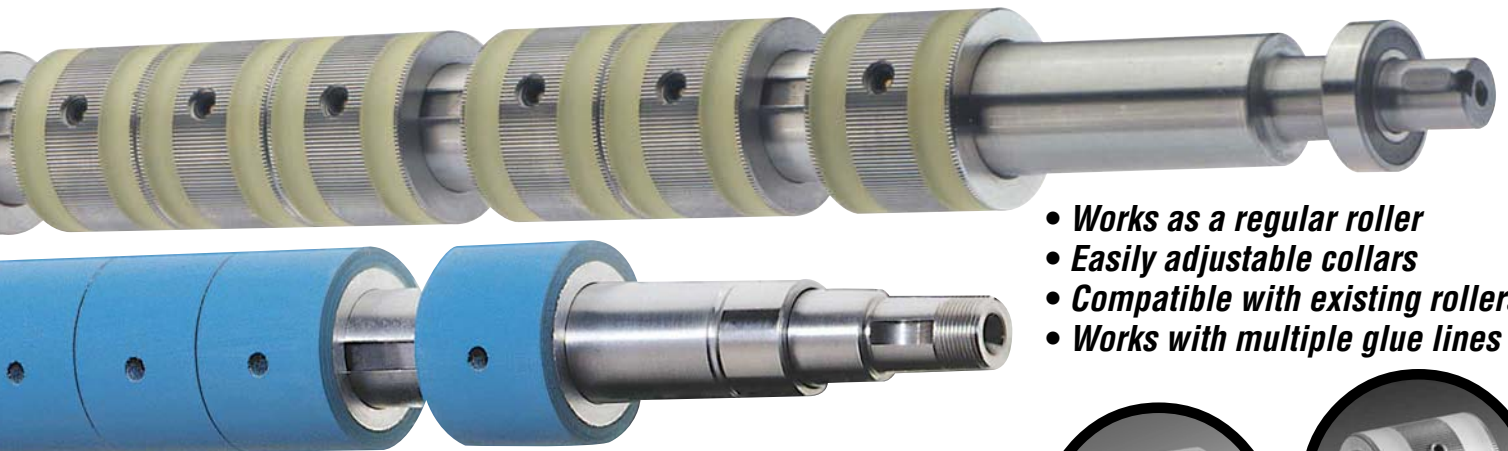

- **Works as a regular roller**
- **Easily adjustable collars**
- **Compatible with existing rollers**
- **Works with multiple glue lines**

Used for gluing operations, these specialized rollers allow you to move glue lines anywhere on the roller. Segments lock in place with a set screw.

How Many Segmented Glue Rollers?

When spot gluing on the register table for a letter fold, a minimum of three segmented glue rollers are required. Although the signature closes between the 4th and 5th roller, a glue relief is still required. This avoids squeezing the glue into the signature.

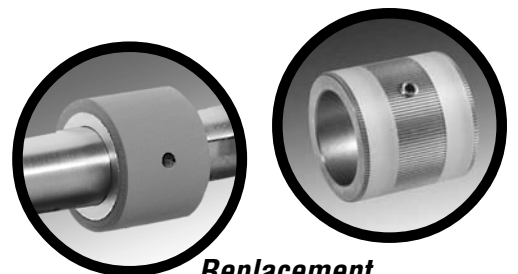

Replacement segments available.

RECOVERY AND REBUILDING KITS

Recover your current rollers the right way!

Not all recovery is the same. Most other recovery processes use a rubber sleeve stretched over the roller body and glued in position. Only **MDI**™ Rollers have molded-in polyurethane segments. The next best thing to replacing your current rollers is to have them remolded - the **MDI**™ way. Our "recoats" provide the advantages of this new process - at a low cost. Call us with the details regarding your present rollers for a quote over the phone.

Roller Recovering Includes:

- *Inspection and straightening*
- *Stripping worn rubber and remolding with urethane*
- *Regrinding to factory specifications*

**MBO Spiral
Roller Regrinding
Now Available!**

ROLLER REBUILD AND SERVICE KITS TO FIT BAUM FOLDERS

MDI stocks a complete supply of parts associated with servicing or replacing fold rollers. Choose our convenient repair kits, or individual parts, to suit varying service or budget requirements.

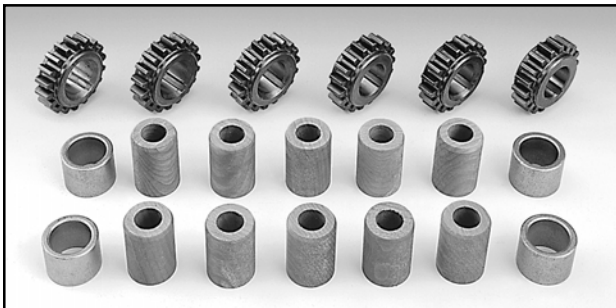

Roller Service Kit -
Contains bushings, gears and keys.

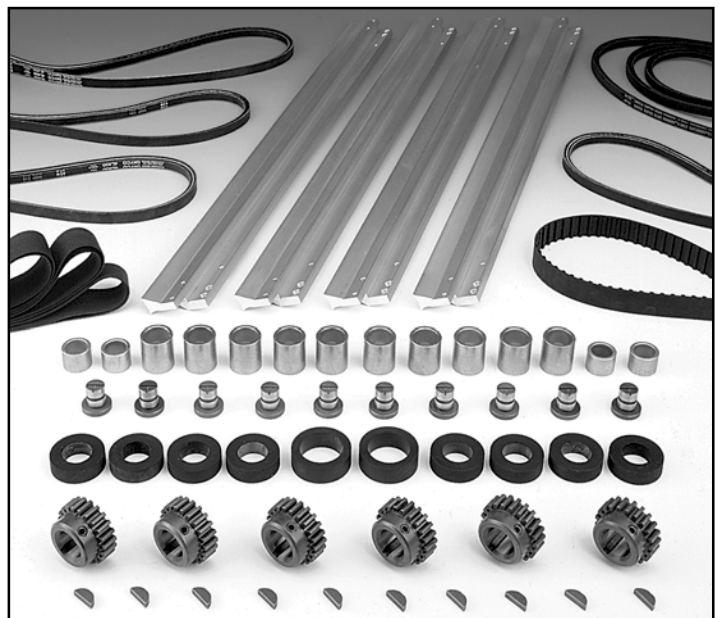

Roller Rebuild Kit - Contains bushings, gears, eccentrics, deflectors, register tapes, tires, V-belts and keys.

MDI also stocks Tabletop Rebuild Kits and Parts!

Competitively priced to restore machine performance for thousands less than a new machine! Contains as many parts as our "Floor Model" Rebuild Kits.

- **Increase Production**
- **Cost Effective**
- **Easy to Install**



BAUM 714

**Over
65
parts!**

*Baum and Profold are registered trademarks

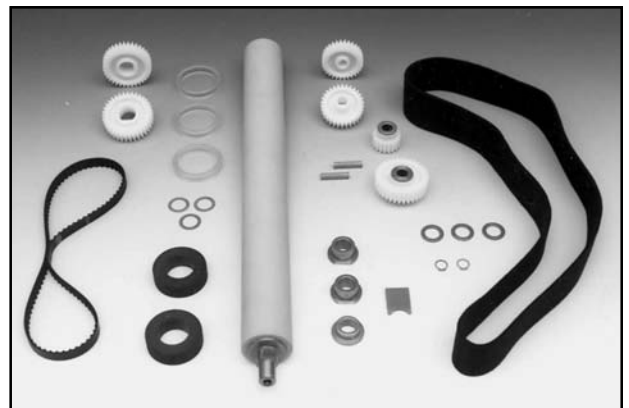

**Quality Aftermarket
Parts For:* **STAHL FOLDERS**

PILE FEED FLAT SUCTION DISC

PART NUMBER 214-170-01-00

SUCKER WHEEL O-RINGS

PART # SIZE - APPLICATION
 203-508-12-00 2.5 x 95mm — T36 ONLY
 203-508-06-00 2.5 x 115mm — ALL MODELS

Inch/Metric Conversion
 INCHES x 25.4 = MM
 MM x .0394 = INCHES

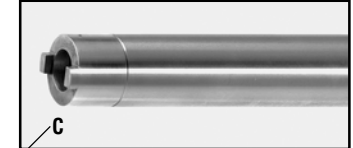

Coupling Style

SLITTER SHAFTS

OEM #	Use	Dia.	Style
218-426-BG-01	T36/B14 Parallel	20mm	A
218-426-BG-02	T36/B14 Parallel	20mm	A
225-545-BG-01	TX52	25mm	B
203-444-BG-22	T56 (SOM) Stahl-O-Mat Parallel	25mm	B
203-444-BG-23	T56 (SOM) 8 & 16 – TF56/56.2 Par. 8 & 16 Pg.	35mm	B
234-006-BG-01	TF56.3/TC56/TD56 Par. 8 & 16 Pg.	35mm	C
203-444-BG-19	T66 (SOM) Stahl-O-Mat Parallel	25mm	B
203-444-BG-20	T66 (SOM) 8 Pg. – TF66/66.2 Par. & 8 Pg.	35mm	B
234-006-BG-03	TF66.3/TC66/TD66	35mm	C
203-444-BG-25	TF78/78.2	35mm	B
231-854-BG-04	TF78.3/TC78.3/TD78	35mm	C
FH1097540	TH82	35mm	C

• Match above slitter shafts to below stub shafts by comparing coupling styles

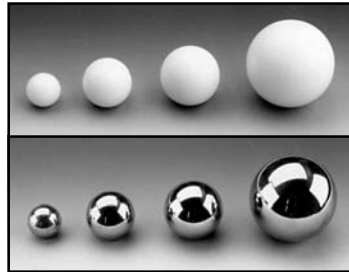

PLASTIC & STEEL BALLS

PART # DESCRIPTION
 200-634-04-00 14mm PLASTIC
 200-634-01-00 20mm PLASTIC
 200-634-02-00 24mm PLASTIC
 200-634-03-00 35mm PLASTIC
 200-132-01-00 14mm STEEL
 200-132-04-00 20mm STEEL
 200-132-05-00 24mm STEEL
 200-132-06-00 35mm STEEL

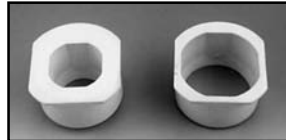

MARBLE CUPS

PART # DESCRIPTION
 206-773-02-00 24mm MARBLE CUP
 206-774-02-00 35mm MARBLE CUP

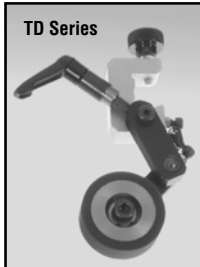

PULL-OUT WHEELS

PART # DESCRIPTION
 208-362-BG-01 SOM, TF, TC
 246-065-BG-01 TD SERIES
 202-854-01-00 WHEEL ONLY

Stub Shafts, Bearings and Drive Couplings

(A) B-14

(B) T & TF Series

(C) TF, TC TD, USA

Stub Shaft Gears Also Available - Please Call

(D) - Slitter Shaft Removable Ends



REGISTER TABLE INFEEED TAPES

PART # SIZE (mm) APPLICATION
 221-056-01-00 30 x 1 x 1235 F36
 200-626-13-00 50 x 1 x 2260 T47/49, B18/19, T50, R52.2
 200-626-05-00 50 x 1 x 2280 F56/66, R56/66 SOM
 200-626-06-00 50 x 1 x 2353 FE (2) 56/66 PILE
 200-626-20-00 50 x 1 x 2920 RF56-112
 232-798-03-00 50 x 1 x 2740 TD56/66/78
 262-723-01-00 50 x 1 x 2873 B24/26



CLAMPING LEVERS

PART # SIZE
 219-326-01-00 M6
 219-327-01-00 M6 x 20
 212-200-01-00 M6 x 25
 200-627-02-00 M8 x 25
 222-608-02-00 M8 x 25 (Brass)
 227-981-BG-01 M8 x 65 (Brass)
 200-628-01-00 M10 x 50
 200-160-02-00 M12



PLATE LOCK LEVERS

PART # MODEL
 204-306-BG-08 T36/B14
 204-306-BG-01 T47/B18, TF56-78, TD56-78, USA B24/26
 204-306-BG-09 USA B20
 204-306-BG-05 T49/B19
 204-306-BG-07 T50/T52

STUB SHAFTS

Ref.	OEM #	Description
A	200-104-11-00	Circlip
	200-584-07-00	Bearing (2)
	200-972-19-00	Spacer
	218-410-01-00	Stub Shaft
	(QST1752)	Drive Coupling
B	200-104-01-00	Circlip
	213-593-01-00	Bearing (narrow)
	203-975-08-00	Spacer
	213-592-01-00	Bearing (wide)
	234-128-BG-01	Stub Shaft
	211-432-01-00	(Use above #234-128-BG-01)
	225-367-BG-01	(Use above #234-128-BG-01)
	(QST1753)	Drive Coupling – 25mm Shaft
	(QST1754)	Drive Coupling – 35mm Shaft
C	200-638-02-00	Cup Washer
	200-104-14-00	Circlip
	213-535-01-00	Bearing (2)
	234-007-BG-01	Stub Shaft (includes bushing)
	(QST1452)	Bronze Bushing Only
	(QST1755)	Drive Coupling
D	202-787-01-00	Slitter Shaft End - Stahl-O-Mat
	216-052-01-00	Slitter Shaft End - Stahl TF
	231-927-01-00	Slitter Shaft End - TF56.3, 66.3, TD, USA
	215-908-01-00	Compression Sleeve
	213-741-01-00	End Cap

MDI has the collars and blade holders you need!

MDI manufactures collars and blade holders to fit a large variety of applications. We use the finest materials available and maintain very strict quality control. Our parts are guaranteed to meet or exceed OEM specifications.



BRASS POINT SET SCREWS

PART #	SIZE - TYPE
200-919-01-00	8 x 8mm W/ BRASS TIP
234-026-01-00	8 x 6mm W/ BRASS TIP

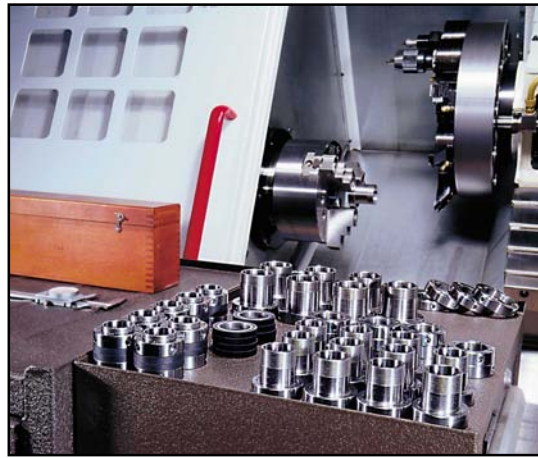

Center Trimming



Edge Trimming

CENTER TRIM SPACER KITS

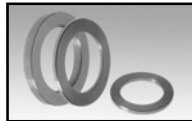

One kit allows you to do all of the following trim outs:
 1/8", 3/16", 1/4", 3/8" & 1/2".
 STSPK30 30mm
 STSPK40 40mm



EDGE TRIM RINGS

PART #	SIZE - TYPE
233-511-01-00	26mm x 36mm x 6mm
233-495-01-00	30mm x 44mm x 6mm
233-459-01-00	40mm x 58mm x 6mm
233-472-03-00	30mm x 44mm w/ Scoring Groove
233-472-01-00	40mm x 58mm w/ Scoring Groove

To find the part number for the collar you need, locate the letter from the corresponding picture, and match it up to the column for the shaft diameter of your machine.

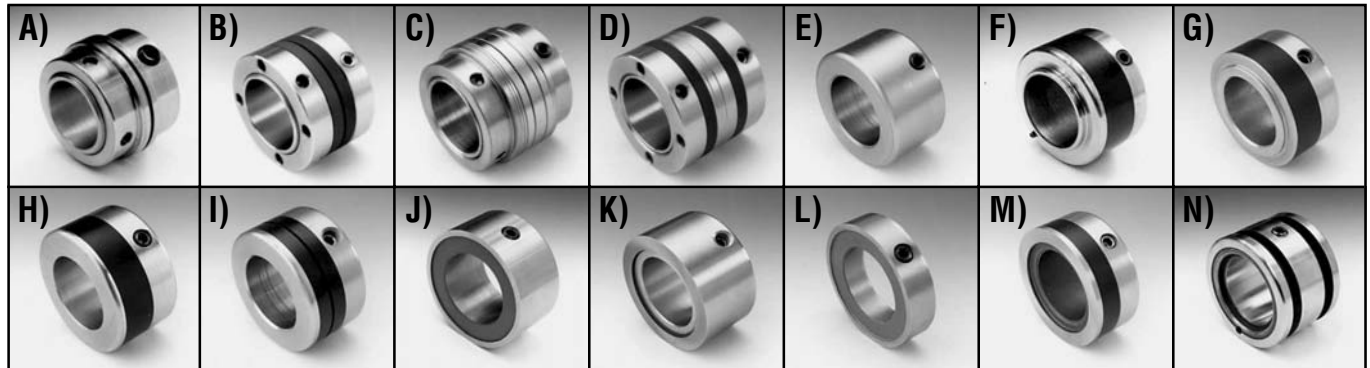

- A) Narrow Blade Holder
- B) Edge Trim Blade Holder w/Trim Rings
- C) Center Trim Blade Holder w/Lip
- D) Center Trim Blade Holder w/o Lip (new style)
- E) Transport Collar - Steel
- F) Transport Collar - Rubber/Steel w/Drive Pin
- G) Transport Collar - Rubber/Steel - Edge Trim
- H) Transport Collar - Rubber/Steel
- I) Transport Collar - Rubber/Steel w/Groove
- J) Counter Knife - Steel
- K) Counter Knife - Steel w/Bushing
- L) Counter Knife - Narrow Two Sided
- M) Counter Knife - Rubber/Steel
- N) Perforator Die Block

20MM SHAFT SIZE (For 26MM ID Blades)

PART NUMBER
A) 203-559-BG-09 (w/ Lip)
B) 203-559-BG-59
C) 203-559-BG-10
D) 203-559-BG-60
E) 203-558-BG-11
F) Not Available
G) 233-423-04-00
H) 203-558-BG-10
I) 218-579-01-00
J) 203-558-BG-12
K) 203-558-BG-12SS
L) Not Available
M) 222-230-BG-04
N) Not Available

25MM SHAFT SIZE (For 30MM ID Blades)

PART NUMBER
A) 203-559-BG-04 (w/ Lip)
213-971-BG-01 (w/o Lip)
B) 203-559-BG-56
C) 203-559-BG-03
D) 203-559-BG-58
E) 203-558-BG-05
F) Not Available
G) 233-423-03-00
H) 203-558-BG-04
I) 213-186-01-00
J) 203-558-BG-06
K) 203-558-BG-06SS
L) 25M-44M-14-DB
M) 222-230-BG-03
N) Not Available

35MM SHAFT SIZE (For 40MM ID Blades)

PART NUMBER
A) 203-559-BG-01 (w/ Lip)
B) 203-559-BG-47
C) 203-559-BG-02
D) 203-559-BG-49
E) 203-558-BG-02
F) 202-845-BG-02
G) 233-423-01-00
H) 203-558-BG-01
I) 217-530-01-00
J) 203-558-BG-03
K) 203-558-BG-03SS
L) 35M-58M-14-DB
M) 222-230-BG-01
N) 202-845-BG-04



"The Roller Specialists" for Folding Equipment Parts
Manufacturing Directions Incorporated

11639 Township Road #76 - Quincy, Ohio 43343
 TEL. (800) 634-0034 • LOCAL (937) 585-5290 • FAX (937) 585-5209